

ARTICULATED HAULER SPECIFICATIONS

ROKBAK

RA40

SPECIFICATIONS

Maximum Payload	38 tonne (41.9 US ton)
Heaped Capacity	23.0m ³ (30.3yd ³)
Gross Power	331 kW (444hp)

FEATURES

Improved operator environment and comfort

Calibrated with the correct balance of power and gearing for effective productive drive to the wheels on all working applications

Moves high levels of materials quickly and efficiently

Lean burning engine for low cost of ownership

Available with EPA Tier 4 Final, EU Stage V or Tier 2 compliant engines

Rokbak RA40 articulated hauler – a smart investment for all working applications





ROKBAK SPECIFICATIONS: RA40

ENGINE 	
Engine	Scania DC13
Type	6 cylinder, in-line, four cycle, direct injection diesel, water cooled, turbo charged with air-to-air charge cooling, electronic engine management and engine exhaust brake.
Piston Displacement litres (in³)	12.7 (775)
Bore x Stroke mm (in)	130 x 160 (5.12 x 6.37)
Gross Power kW (hp) @ rpm	331 (444) @ 2,100
Net Power kW (hp) @ rpm	328 (440) @ 2,100
Maximum Torque Nm (lbf ft) @ rpm	2,255 (1,663) @ 1,300
Gross Power Rated	ISO 3046
Engine Emissions	US EPA Tier 4F, EU Stage V and Tier 2 derivatives.
Electrical	24 volt electric start. 100 A alternator. Two 12 volt 180 Ah batteries.
Air Cleaner	Dry-type 3-stage, aspirated air cleaner with safety element, automatic dust ejector and restriction indicator.
Fan	Modulating fan reduces noise level and consumes engine power as required. Note: Net hp with fan clutch disengaged.
Altitude m (ft)	Electronic derate from 2,000 (6,561)

TRANSMISSION 				
Type	Allison HD4560 with integral retarder mounted directly to the engine, fully automatic transmission with planetary gearing, electronic control with six forward and one reverse gear.			
Assembly	Remote mounted 2-speed transfer gearbox taking drive from the transmission and feeding it via a lockable differential to front and rear wheels.			
Speeds km/h (mph)	Ratio 1 Low Speed	Ratio 2 High Speed		
Gear	Forward	Reverse	Forward	Reverse
1	6.0 (3.7)	5.0 (3.1)	9.5 (6.0)	7.8 (4.8)
2	11.3 (7.0)	–	16.0 (10.0)	–
3	16.5 (10.3)	–	25.3 (15.7)	–
4	25.6 (16.0)	–	39.2 (24.4)	–
5	33.9 (21.0)	–	51.9 (32.3)	–
6	41.7 (26.0)	–	63.8 (40.0)	–

AXLES 	
Type	Three axles in permanent all-wheel drive (6x6) with differential coupling between each axle to prevent driveline wind-up. Heavy duty axles with full floating axle shafts and outboard planetary reduction gearing. Automatic limited slip differentials in each axle. Leading rear axle incorporates a through drive differential to transmit drive to the rearmost axle. This differential and the dropbox output differential are locked simultaneously using one switch selected by the operator.
Differential Ratio	3.70 : 1
Planetary Reduction	6.35 : 1
Overall Drivetrain Reduction	23.50 : 1

SUSPENSION 	
Front	Four trailing links and a panhard rod locate the front axle giving a high roll centre. The optimised front axle position along with the wide spaced main and rebound mounts, mounted directly above the axle and long suspension travel, combine with the two heavy duty dampers each side to give excellent handling and ride.
Back	Each axle is coupled to the frame by three rubber-bushed links with lateral restraint by a transverse link. Pivoting inter-axle balance beams equalise load on each rear axle. Suspension movement is cushioned by rubber/metal laminated compression units between each axle and underside of balance beam ends. Pivot points on leading and trailing links are rubber-bushed and maintenance-free.

STEERING 	
Type	Hydrostatic power steering by two double-acting cushioned steering cylinders with pressure supplied by a variable displacement/load sensing piston pump. Secondary steering pressure provided by a ground driven pump.
Steering Angle to Either Side	45°
Lock to Lock Turns, Steering Wheel	2-5
System Pressure Bar (lbf/in²)	240 (3,480)
SAE Turning Radius mm (ft-in)	9,185 (30-1)
Clearing Radius mm (ft-in)	9,675 (31-9)

ROKBAK SPECIFICATIONS: RA40

FRAME

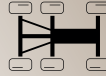

Type

Front and rear frames are all-welded high grade steel fabrications with rectangular box-section beams forming the main side and cross members. Inter-frame oscillation is provided by a large diameter cylindrical coupling which houses nylon bushings. Frames articulated 45° to either side for steering by means of two widely-spaced pivot pins in back-to-back sealed taper roller bearings.

BODY



Type

All-welded construction, fabricated from high hardness (min 360 BHN) 1,000 Mpa (145,000 lbf/in²) yield strength steel. Dual slope tailchute improves material ejection from body.

Plate Thickness mm(in): Floor and Tailchute Sides Front

15.0 (0.58)
12.0 (0.47)
8.0 (0.31)

Volume m³ (yd³): Struck Heaped 2:1 (SAE)

17.4 (22.8)
23.0 (30.3)

HOIST



Type

Two single-stage, double-acting hoist cylinders, cushioned at the base end. Variable displacement/load sensing piston pump driven from power take-off on transmission. Full flow return line filtration. Full electro-hydraulic hoist control, with electronic detent in power down.

System Pressure bar (lbf/in²)

240 (3,480)

Pump Output Flow Rate: litre/sec (gal/sec)

5.4 (1.43)

Raise (loaded) Seconds

12.5

Lower Seconds

8

TYRES AND WHEELS



Tyres

Standard 29.5

Rims

Standard 25x25.00

Wheels

3-piece earthmover rims with 19 stud fixing.

BRAKES



Tyres

All hydraulic braking systems with enclosed multiplate sealed and force oil cooled brake packs at each wheel. Independent circuits for front and rear brake systems.

Parking

Spring-applied, hydraulic-released disc on rear driveline.

Secondary

Secondary brake control actuates service and parking brakes.

Retarder

Exhaust brake and transmission retarder.



ROKBAK SPECIFICATIONS: RA40

DIMENSIONS

	mm	ft-in
A	3,945	13-0
B	3,752	12-4
C	3,561	11-8
D	539	1-9
D1	540	1-9
E	1,834	6-0
F	2,596	8-6
G	3,358	11-0
H	1,495	4-11
I	3,087	10-1
J	1,310	4-4
K	2,987	9-10
L	1,950	6-5
M	1,779	5-10
N	11,115	36-5
O	916	3-0
P	2,479	8-2
Q	3,152	10-4
R	6,933	22-9
S	5,658	18-6
T	5,575	18-3
U	3,129	10-3
V	3,318	10-11
W	3,364	11-0
X	3,633	11-11

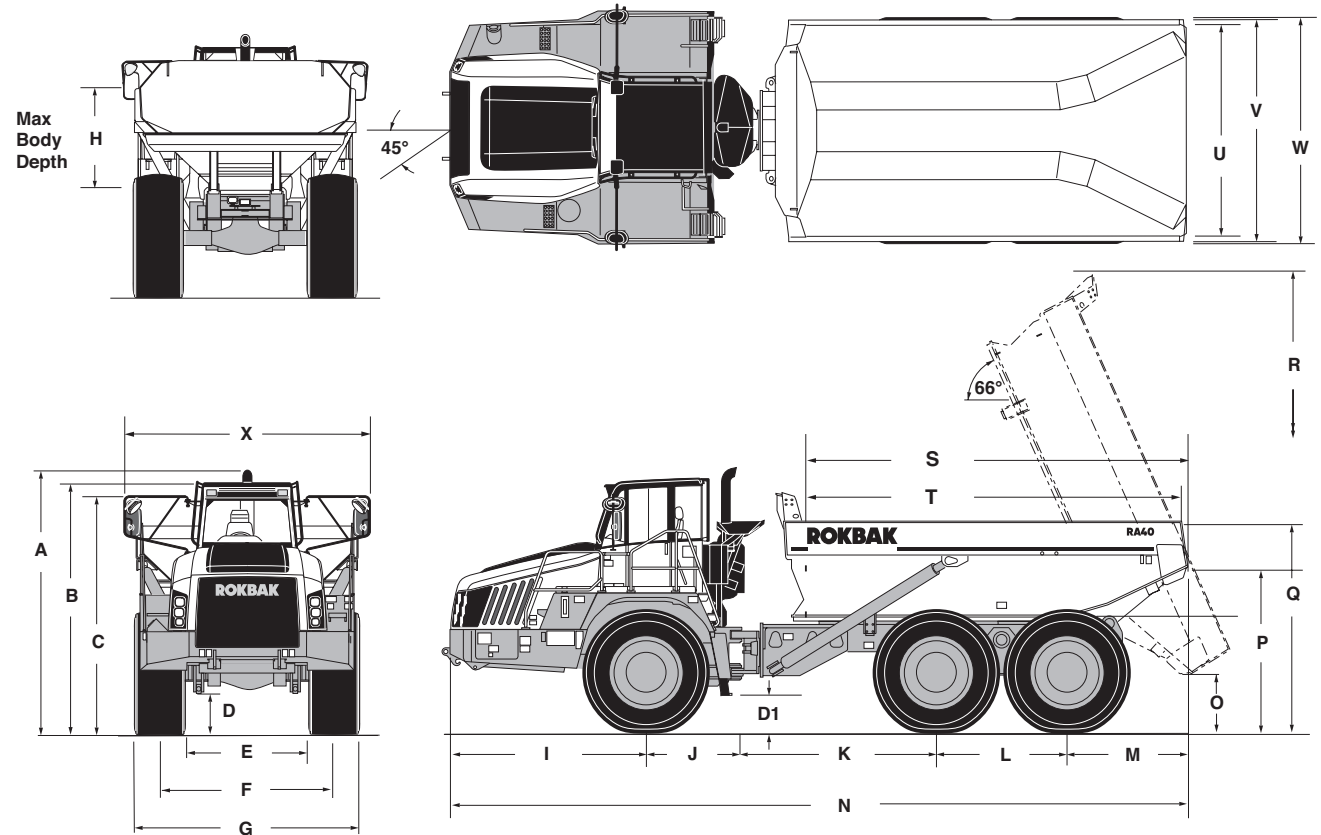

ROKBAK SPECIFICATIONS: RA40

WEIGHTS



	EU Stage V Models		Tier 4 Final Models		Tier 2 Models	
	kg	lb	kg	lb	kg	lb
Net Distribution						
Front Axle	17,046	37,580	17,001	37,481	16,743	36,912
Centre Axle	7,789	17,171	7,385	16,281	7,445	16,413
Rear Axle	7,586	16,724	7,521	16,581	7,393	16,299
Vehicle, Net	32,421	71,476	31,907	70,343	31,581	69,624
Payload	38,000	83,775	38,000	83,775	38,000	83,775
Gross Distribution						
Front Axle	19,040	41,976	18,500	40,786	18,742	41,319
Centre Axle	25,653	56,555	25,100	55,336	25,422	56,045
Rear Axle	25,646	56,555	25,160	55,468	25,485	56,184
Vehicle Gross	70,339	155,070	68,760	151,590	69,649	153,548
Ancillary Weights						
Frame	5,468	12,055	5,468	12,055	5,450	12,015
Body	5,400	11,905	5,400	11,905	5,400	11,905
Hoist, Pair	660	1,455	660	1,455	660	1,455

GROUND PRESSURE



These figures are at 15% shrinkage of unloaded radius and specified weights using:

Tyres	29.5 R25	
Loaded	kPa	Psi
Front	372	54
Rear	469	68

These pressures are for standard tyres.

CAPACITIES



	Litres	US gal
Fuel Tank	500	132
Hydraulic System (steering and body)	341	90
Engine Crankcase	45	11.8
Cooling System	70	18.5
Transmission (inc filters and cooler)	48	12.7
Differential – Front and Rear (each)	38	10
Differential – Centre	39	10.3
Planetaries (each)	8.5	2.2
Brake Cooling System	188	49.7
DEF System*	38	10
Drop Box	17	4.5

*Only applicable on Tier 4 Final/EU Stage V

SOUND LEVELS



Sound level in cab according to ISO 6396:2008

LpA: dB(A) 70

Sound level in cab according to ISO 6395:2008

LpA: dB(A) 109



GRADEABILITY



Unit equipped with 29.5 R25 tyres. Graphs based on 2% rolling resistance.

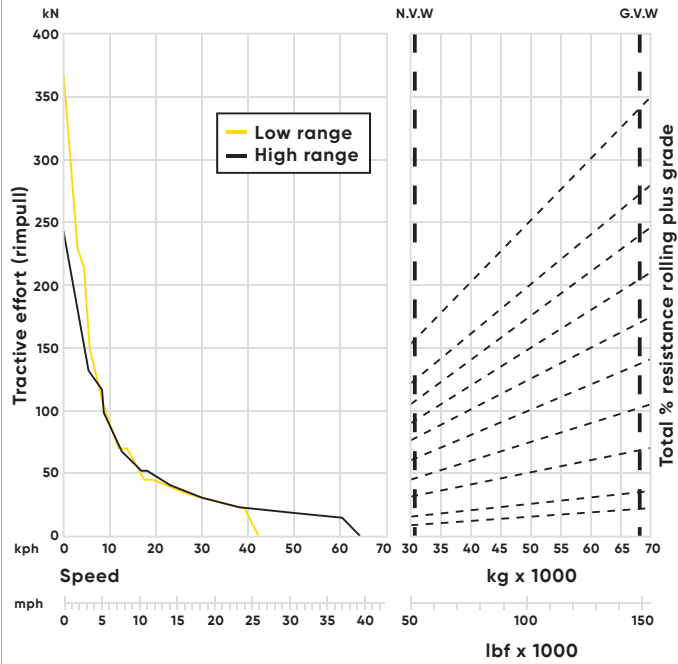

RETARDATION



Instructions: From intersection of vehicle weight with percentage resistance line read across to determine maximum gear attainable, and then downwards for vehicle speed.

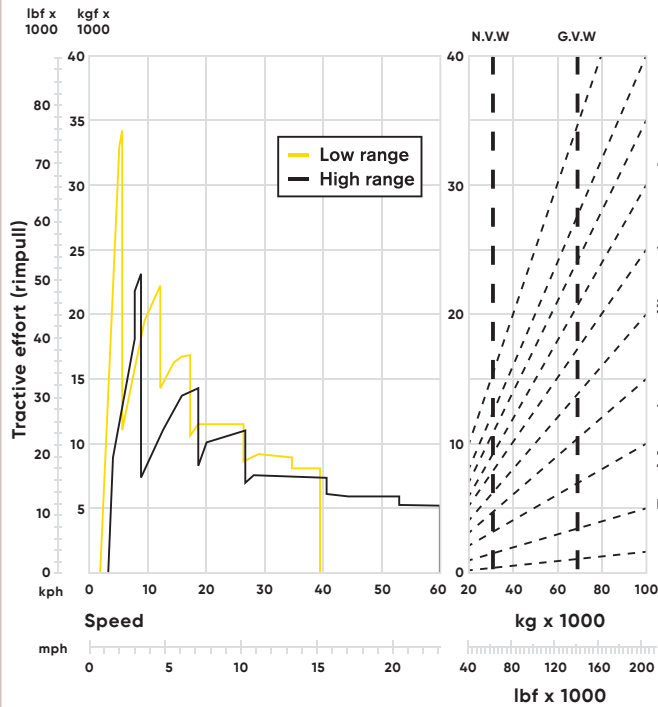

ROKBAK SPECIFICATIONS: RA40

STANDARD EQUIPMENT



CAB AND OPERATOR

Air Conditioning	✓	Rear Vision Camera/Monitor	✓
Air Filter Restriction Indicator	✓	ROPS/FOPS Protection ISO3471/3449	✓
Auxiliary Power Outlets 12V & 24V	✓	Seat Belts Retractable J386	✓
CD/Tuner/MP3 Connectivity	✓	Seat, Operator, Air Suspension, High Back, Headrest and Adjustable Armrests	✓
Coat Hook	✓	Seat, Trainer	✓
Engine/Transmission/Hydraulic Diagnostic Facility	✓	Steering Wheel, Tilt/Telescopic	✓
Heating, Ventilation and Air Conditioning System (HVAC)	✓	Storage Compartment	✓
HEPA Cab Air Filter	✓	Sun Visor (internal)	✓
Insulation, Thermal & Acoustic	✓	Tinted Glass	✓
Interior Light	✓	Window Protection Grill, Rear	✓
Mirror Rear View (4)	✓	Wiper and Washer, Front and Rear Windows	✓
Mug Holder	✓		

WARNING LIGHTS AND AUDIBLE ALARM

Alternator Charging	✓	Engine 'STOP'	✓
Body Up	✓	Exhaust Brake	✓
Brake Cooling Oil Pressure	✓	Front Brake Accumulator Pressure	✓
Brake Cooling Oil Temperature	✓	Headlight High Beam	✓
Differential Lock	✓	Headlights Active	✓
Direction Indicators	✓	Hydraulic Oil Filter Change	✓
Dropbox High/Low Oil Pressure	✓	Hydraulic Oil Level Low	✓
Dropbox High/Oil Temperature	✓	Low Fuel	✓
Dropbox High/Ratio Selected	✓	Parking Brake	✓
Dropbox Low/Ratio Selected	✓	Rear Brake Accumulator Pressure	✓
Engine Air Filter Change	✓	Reverse Alarm Audible J994	✓
Engine 'CHECK'	✓	Secondary Steering	✓
Engine Coolant Level Low	✓	Transmission Check	✓
Engine Oil Pressure Low	✓	Transmission High Oil Temp	✓
Engine Over-speed Active	✓	Transmission Retarder	✓

GENERAL

Articulation and Oscillation Lock	✓	Manual Body Lower - EU Stage V only	✓
Battery Master Switch	✓	Modulating Cooling Fans	✓
Body Prop	✓	Mudflaps at Front and Centre	NA
Brakes Fully Hydraulic Dual Circuit System	✓	Neutral Start Interlock	✓
Diagnostic Pressure Test Points	✓	Pivot Protection Guard	✓
Differential Locks	✓	Rear Light Guards	✓
Electronic Assisted Body Hoist Control	✓	Secondary Steering	✓
Emergency Body Lower (EU Only)	NA	Security Kit	✓
Engine/Transmission/Hydraulic Electronic Management System	✓	Tilting Cab for Maintenance	✓
Exhaust Brake	✓	Tow Points, Front and Rear	✓
Exhaust Muffler	✓	Transmission Downshift Inhibitor	✓
Handrails on Fenders	✓	Transmission Oil Cooler	✓
Horn, Electric 117db	✓	Transmission Retarder	✓
Hydraulic Filter Restriction Indicator	✓	Transmission Sump Guard	✓
Hydraulic Oil Cooler	✓	Tyre Inflation Nitrogen	✓
Independent Suspension	✓		

GAUGES

Body Tip Counter	✓	Fuel Level	✓
Brake Oil Temperature	✓	Hourmeter	✓
DEF Level Gauge (T4 variant only)	✓	Hydraulic Oil Temperature	✓
DEF Level Warning (T4 variant only)	✓	Speedometer/Digital Odometer/Tripmeter	✓
Engine Coolant Temperature	✓	Tachometer	✓
Fuel Consumption/Usage	✓	Transmission Oil Temperature	✓

LIGHTS

Direction and Hazard Warning Indicators (LED on Rear)	✓	Side and Tail (LED)	✓
Front Working Lights, Roof Mounted	✓	2 Halogen Headlamps Dipped Beam	✓
Reverse Warning	✓	2 Halogen Headlamps Main Beam	✓

OPTIONAL EQUIPMENT



BODY OPTIONS

Body Side Extensions	✓	Manual Body Lower for Tier 4 Final/T2 Variations	✓
Heated Body	✓	Spillguard Extension	✓
Liner Plates	✓	Chain Operated, Scissor Type, Rear Tailgate	✓

MIRRORS

Mirror Front Mounted	✓	Mirrors Heated	✓
----------------------	---	----------------	---

LIGHTS

Beacon Flashing	✓	Rear Working Lights, Roof Mounted	✓
Fog Rear	✓	Reverse Flashing	✓

OTHER OPTIONS

Automatic Lubrication	✓	Payload Monitoring System	✓
Fast Fuel	✓	Seat Heated	✓
Fire Extinguisher	✓	Tool Kit	✓
First Aid Kit	✓	Haul Track Telematics*	✓
Inclinometer/Body Tilt Warning Buzzer and Dashboard Light	✓		

*Fitted as standard on EPA Tier 4 Final and EU Stage V engine machines. Ask for details.

ROKBAK

Effective date: September 2021. Product specifications and prices are subject to change without notice or obligation. The photographs and/or drawings in this document are for illustrative purposes only. Refer to the appropriate Operator's Manual for instructions on the proper use of this equipment. Failure to follow the appropriate Operator's Manual when using our equipment or to otherwise act irresponsibly may result in serious injury or death. The only warranty applicable to our equipment is the standard written warranty applicable to the particular product and sale and Rokbak makes no other warranty, express or implied.

© 2021 Rokbak. Ref: TTADTEN

Rokbak

Newhouse Industrial Estate, Motherwell, Scotland, ML1 5RY

t: +44 (0) 1698 732 121 f: +44 (0) 1698 734 046